

HYC = 542+PRO

Radio PMPT TDMA COFDM Space Diversity

Ethernet vidéo audio data + RS232-RS485



USER MANUAL

MANUEL DE L'UTILISATEUR

Versions 2019 & 2018

HYC-542+PRO User Manual version 2019

Product Introduction:

HYC-542 TDD_COFDM this product is our company released latest mini type pure Digital wireless transmission equipment, the use of advanced time division Processing technology and leading COFDM modulation technology, providing a Complete two-way data transmission channel, high-definition video transmission channel, the perfect realization of real-time, high-speed mobile data, audio and video transmission.

Applications:

Compact size, light weight, widely application for UAV system, high speed railway, fire fighting, security, intelligence control and other complex environments.

Product features:

- Support for up to 20Mbps data flow, adaptive dynamic stream allocation technology
- Support multiple bandwidth regulation (2M/4M/8MHZ), adaptive modulation and manual modulation mode selection.
- Support diversity antenna reception
- Support 128 bit AES encryption
- Support transparent PTP&PMD network transmission technology
- Support non line of sight (NLOS), high-speed mobile transmission
- Support high standard industrial applications
- Provide standard RS-232 & RS-485+RJ45 interface
- High definition OLED panel digital display, simple interface easy to operation
- Small size, light weight, low power consumption

Interface description:



Outline drawing:



Model	HYC-542
Power input	DC 7~17V
Ethernet	10/100 BaseT,Auto-MDI/X,IEEE 802.3
	TCP,UDP,TCP/IP,ARP,ICMP,DHCP,HTTP,SNMP,FTP,DNS
Data input	RS-232&RS-485-H/RS-485-F
	RJ45
Output frequency	2402MHz-2482MHz,Step 1MHz adjustable
Output power	30dBm/1W
Bandwidth	2MHz /4MHz/8MHz
Encryption	128 bit AES
Correction mechanism	32 bit of CRC,ARQ
Modulation	TDD-COFDM,Time division duplex mode
RF Antenna interface	MMCX
Parameter control	By adjusting the parameters of OLED control
Dimensions	74m*52mm*20mm
Weight	90g

HYC-542 Technical parameters:

HYC-542/OLED control panel parameter settings:

The control panel is composed of OLED LCD screen and three buttons:

Which are ◀ ▶ menu key, ▲ increase key, ▼ decrease key

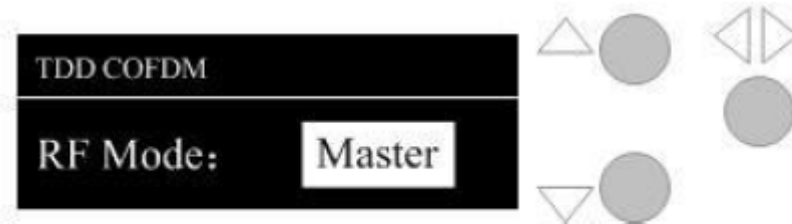

RF Mode:

RF mode, Master /Slave (one radio need to setting master mode, another radio need to setting as slave mode will be workable)

Freq:

operating frequency work as 2402-2488MHz

Band:

Working bandwidth 2.0MHz/4.0MHz/8.0MHz

Level:

output power adjustable range 7dBm~30dBm, stepping 1dBm (27dBm recommended)

Modem:

- Auto(Automatically adjusts the gain and code stream runs in optimal mode according to the real-time testing environment, However, when the video screen is switched, the delay time will become bigger. If the code stream is fixed, we recommend using the 2MHZ bandwidth QPSK 1/2 or 4MHZ bandwidth QPSK 3/4 for High-speed mobile environment.
- QPSK 1/2, QPSK 3/4
- QAM16 1/2, QAM16 3/4,
- QAM64 2/3, QAM64 3/4, QAM64 5/6,

Note: QPSK is low data speed but long range and 64QAM max data speed but shorter range, we don't recommend using 16QAM and 64QAM mode for high-speed mobile environments because it has a large impact on the range. Please adjust the size of the bit stream according to different modulation modes.

AES: 128 AES encryption and key settings

Diversity: diversity reception setting; ON/OFF selection

ComMode: Port mode RS232/RS485-H(RS485 half duplex)/RS485-F(RS485 full duplex)

Baud rate: Baud rate selection (300/600/1200/2400/3600/4800/7200/9600/14400/19200/28800/38400/57600/115200)

Local ID: local ID settings, 1-48 (master ID and slave ID can not setting to be the same)
Remote ID: remote ID settings, 1-48 (data transfer needs to be set to other side of the local ID)

For examples: When you set the RF mode Master Local ID is 7 and Remote ID is 8 and another radio need to be setting RF mode is Slave, Local ID is 8 and Remote ID is 7 (Local ID and Remote ID only for serial ports)

Please refer to the below photoes:



Another radio should be setting as below:



According to the following picture to set the relevant operation, that can be change the HYC-542 parameters through the control panel.

1> Modified user's RF Mode master and slave settings

Firstly, power on the radio.



Press "◀▶" key and keep 3 seconds to enter the parameter setting mode, then the OLED LCD screen of the "Master" option is white character shading, as shown below:

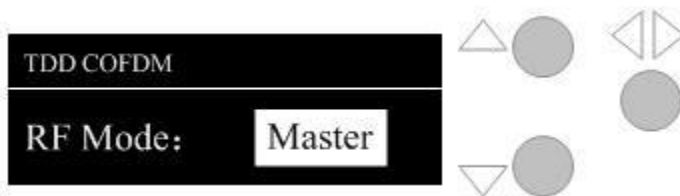

2>press "△" or "▽" switch to the desired mode and press "◀▶", wait for 5 seconds LCD screen transform prompt "Success" means that the adjustment has been completed, as shown below:

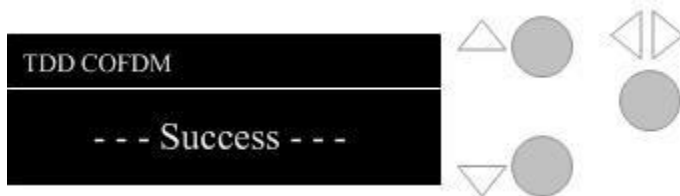

3> Other parameter settings

Power on the radio at this time the OLED LCD screen displays the RF Mode option, adjust the system frequency from 2405MHz to 2425MHz for example; When the radio is powered on, the OLED LCD panel displays the RF Mode option.

4> Press ▽ or △ switch to Freq option



5> Long press “◀▶” key and keep 3 seconds to enter the parameter setting mode, the OLED LCD screen of the first parameter is white character shading, then press “◀▶” key to move to the location you want to modify the parameters.



6> press ◀ or ▶ to adjust the parameter values, then OLED to be adjusted in steps of 1MHz, until it is adjusted to the desired value.

7> When adjusted to the required value, long press “◀▶” key for 3 seconds, white character shading disappears, the LCD screen transforms to prompt “Success” it indicates that the adjustment has been finished, the other parameters setting, please refer to the above method.

8> If you don't want to save the parameters, lightly press ◀▶ button, give up to modification and exit parameters setting mode, return to normal display interface.

Remark:

OLED display frequency range is determined by the working frequency of transmitter, the specific value please refer to the device shown on the label. TX parameters (frequency, bandwidth, AES) settings must keep consistent with RX, otherwise the device cannot work.



Use the device needing attention:

1> Before power on the device, **be sure to check the antenna interface whether is load**, in order to avoid antenna interface short circuit or open circuit.

Note:

Before powering on the device, should be first connect with antenna then connected to power supply, removal of device should be turn off the power at first. If you first connect the power or remove the device before powered up, it may cause the device damage.

2> Antenna selection, should be selected according to the use of the frequency band. If you required for long-distance transmission, had better to chose directional antenna improve the system gain.

Note:



- The system powered on must connected the antenna completely.

- The system must be powered off / disconnect the power before to remove the antenna.

HYC-542+PRO User Manual version 2018

Table des matières

HYC-542 User Manual.....	8
Specifications	9
01 – HYC-542 Description	10
02-Transmitter control panel instruction:	11
Function and Usage Method of this device:	12
Use the matters needing attention:	12
04- Configuration PTP et PMPT.....	16
04- Configuration PMPT with relay.....	17
04- Images de la mise en service HYC540 (id HYC 542)	18
Format des trames :	20
05- Mesures débit IP sur RJ45 HYC540	22
06 – HYC-540/542/550 EC Declaration of Conformity.....	23
07- HYC-542-PRO 5/10 watts.....	24
08- HYC-542-Functions reset	25
Step for the factory reset:	25

Specifications

- **2 Antennes mobiles embarquées :**
 - Hélice, Quadrifilaire
 - Zeppelin
 - Blade
 - Demi-onde
- **Emetteur Récepteur IP TDD COFDM** ultra léger en boîtier aluminium usiné.
- **Full Duplex** transmet et reçoit de la vidéo HD ou SD en H264 et des data.
- Configuration du menu pour opérations en temps réel avec pré-réglages.
- Hautes performances de la modulation COFDM et de la diversité d'espace.
- Longue portée sans pointage d'antennes (Quadrifilaires Omnidirectionnelles)
- Récepteurs Emetteurs multiples en PMPT et monitoring selon les applications.
- Fonctionne en mode non à vue en mobile à haute vitesse de déplacement.
- 2 antennes en diversité d'espace

- **Fréquences:** 2402 – 2488 MHz (Pas de 1 Mhz)
- **Puissance:** 30 dBm – 1 watt
- **Seuil de sensibilité:** -95 dBm
- **Latence :** < à 2 Ms
- **Débit total :** 20 Mbps Débit IP, allocation de flux adaptatif
- **Alimentation:** 7/17 VDC 6 watts
- **Modulation:** COFDM Time Division Duplex mode
- **Canaux:** de 2, 4, 8, MHz au pas de 1 MHz
- **Ethernet:** 10/100 BaseT Auto-MDI/X IEEE 802.3 TCP , UDP,TCP/IP,TFTP,ARP,ICMP,DHCP,HTTP,SNMP,FTP,DNS
- **Encryption:** AES 128 bit (AES 256 bits sur demande)
- **Correction d'erreurs:** CRC-ARQ 32 bits
- **Température de service:** -35° +75° C
- **Dimensions poids:** 74x52x20 mm 90 grammes
- **Réglages:** écran de contrôle OLCD
- **RF interface antenne:** MMCX

Product features:

- Support for up to 20Mbps data flow, adaptive dynamic stream allocation technology
- Support multiple bandwidth regulation (2M/4M/8M), adaptive modulation and manual modulation mode selection
- Support diversity antenna receiver
- Support 128 bit AES encryption
- Support transparent PTP&PMD network transmission technology
- Support non line of sight (NLOS), high-speed mobile transmission
- Support high standard industrial applications
- Provide standard RS-232 & RS-485 + RJ45 interface
- High definition OLED panel digital display, simple interface easy to operation
- Small size, light weight, low power consumption

01 - HYC-542 Description

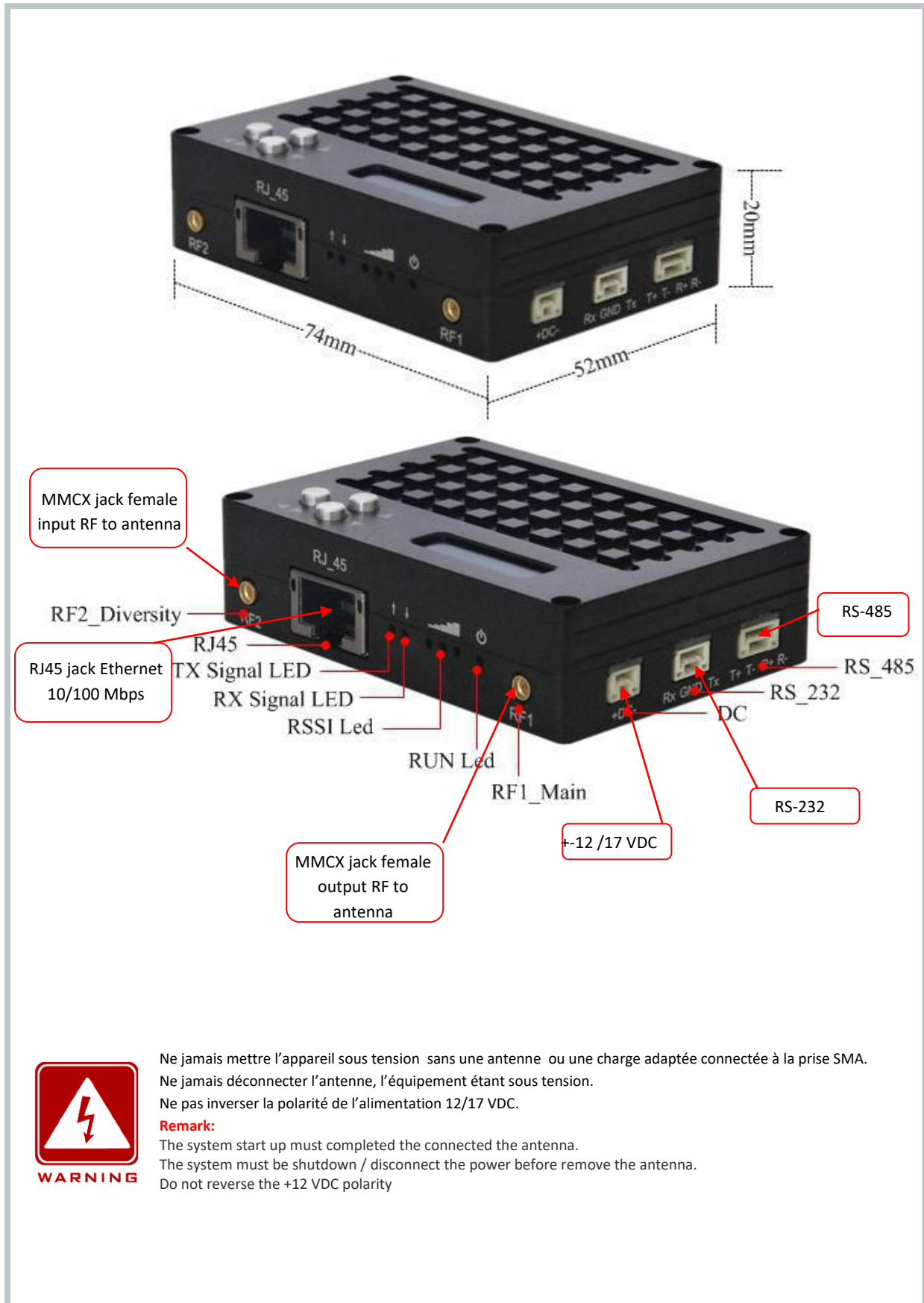

Ne jamais mettre l'appareil sous tension sans une antenne ou une charge adaptée connectée à la prise SMA.
Ne jamais déconnecter l'antenne, l'équipement étant sous tension.
Ne pas inverser la polarité de l'alimentation 12/17 VDC.

Remark:

The system start up must completed the connected the antenna.
The system must be shutdown / disconnect the power before remove the antenna.
Do not reverse the +12 VDC polarity

02-Transmitter control panel instruction:

Transmitter control panel is composed of LED screen display

“◀ ▶” menu key “▲” increase key and “▼” decrease key

Display function description:

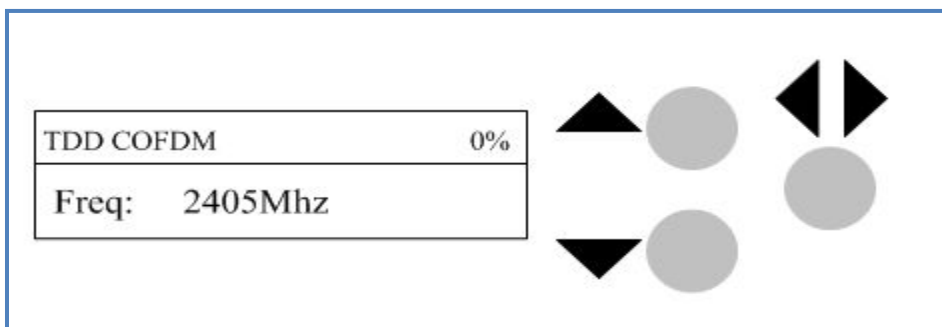

0% this is the signal strength, if receive the signal indicates communication is no problem.

Note : Start up the system need 45 seconds (connected power supply can start the Radio)

ID user name:	User
RF Master:	master / slave to set
Freq:	frequency 2405-2470MHz, step 1MHz
The Band:	bandwidth of 2.0MHz/2.5MHz/4.0MHz/8.0MHz
Level:	output power installation, stepping 1dB
AES-128:	encryption OFF/ON optional
Encryption key:	need to open the encryption can use it. Encryption key of values and the encryption key of corresponding receiver values must have the same.
Com Mode:	RS232/RS485 channel selection
Bit rate:	data transmission rate setting
Data Format:	data format
Poe:	standby
Success:	parameter set success (appeared after modify and save parameters)

According to the below picture to set the relevant operation, that can be change the Transmitter parameters through the control panel.

Function and Usage Method of this device:

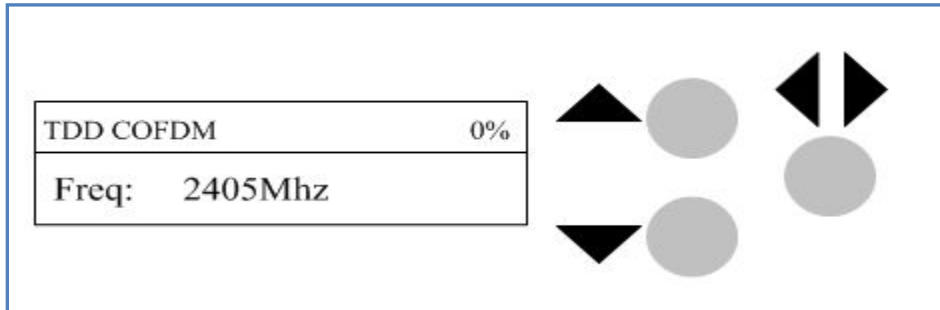

- 1> Forexample, equipment power system frequency from 2405MHz to 2440MHz
- 2> Long press “◀ ▶” key and keep 3 seconds, enter setting state, at this time LCD screen of the first parameter is black character shading, press “▼” or “▲” move to the position of modify the parameters.
- 3> Press “▲” or “▼” to adjust numerical of the parameters, at this time LCD is adjusted stepping by 1MHz , until to the required numerical.
- 4> Adjusted to the required data, long press “◀ ▶” key and keep 3 seconds, black character shading disappear, on the LCD display show “Success” it indicates that the adjustment has been finished, other parameters setting method, please refer to the above method.
- 5> If you don’t want to save the parameters, lightly press “◀ ▶” button, give up to modification the exit parameters setting mode, return to normal display interface. The master need to connect the computer, the slave need to connect the webcam. If no problem please open your IE browser and enter your Webcam address. Then you can got amazing video.

Remark:

LED display frequency range is decided by Transmitter working frequency, Transmitter frequency must consistent with Receiver frequency.



WARNING

Use the matters needing attention:

1> Before power on the device, must be check the antenna interface whether is load, in order to avoid antenna interface short circuit or open circuit.

Note: Before the device is switched on the power, the device should be first connect with antenna then connect with the power supply, removal of device should be first turn off the power. If you use the device, first switched on the power, connect antenna later, it may cause the device damage.

2>Antenna selection, should be selected according to the use of the frequency band.If you want for long distance transmission, choose the directional antenna to improve the system gain.

The control panel is composed of OLED LCD screen and three buttons:

Which are “◀ ▶” menu key, “▲” increase key and “▼” decrease key

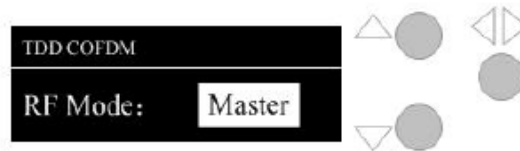

RF Mode: RF mode, Master /Slave (one of the radio must setting master mode,another setting as slave mode will be workable)

Freq: operating frequency work as 2402-2488MHz

Band: working bandwidth 2.0MHz/4.0MHz/8.0MHz

Level: output power adjustable range 7dBm-30dBm, step 1dB

Modem: modulation and demodulation mode;

AES: 128 AES encryption and key settings

Diversity: diversity receiver settings; ON/OFF selection

ComMode: Port mode RS232/RS485-H/RS485-F

Baud rate: data transfer rate setting

Local ID: local ID settings, 1-48 (master ID and slave ID can not be the same)

Remote ID: remote ID settings, 1-48 (data transfer needs to be set to other side of the ID)

According to the following picture to set the relevant operation, that can be change the HYC-542 parameters through the control panel.

1>Modified user's RF Mode master and slave settings

Firstly,power on the radio.



Press “◀ ▶” key and keep 3 seconds to enter the parameter setting mode, then the OLED LCD screen of the "Master" option is white character shading, as shown below:



2>press "▲" or "▼" switch to the desired mode and press "◀ ▶",
wait for 5 seconds LCD screen transform prompt "Success" means that
the adjustment has been completed, as shown below:

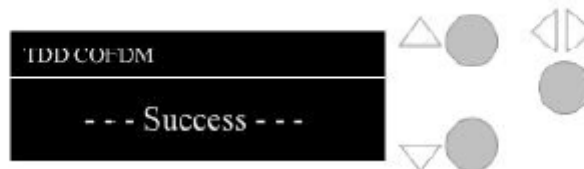

3> Other parameter settings

Power on the radio at this time the OLED LCD screen displays the RF Mode option, adjust the system frequency from 2405MHz to 2425MHz for example; When the radio is powered on, the OLED LCD panel displays the RF Mode option.

4>Press "▼" or "▲" switch to Freq option



5>Long press "◀ ▶" key and keep 3 seconds to enter the parameter setting mode, the OLED LCD screen of the first parameter is white character shading, then press "◀ ▶" key to move to the location you want to modify the parameters.



6>press “▲” or “▼” to adjust the parameter values, then OLED to be adjusted in steps of 1MHz, until it is adjusted to the desired value.

7> When adjusted to the required value, long press “◀ ▶” key for 3 seconds, white character shading disappear, the LCD screen transform prompt “Success” it indicates that the adjustment has been finished, the other parameters setting, please refer to the above method.

8> If you don't want to save the parameters, lightly press “◀ ▶” button, give up to modification and exit parameters setting mode, return to normal display interface.



WARNING

Remark:

OLED display frequency range is determined by the working frequency of transmitter, the specific value please refer to the device shown on the label. TX parameters (frequency, bandwidth, AES) settings must keep consistent with RX, otherwise the device can not work. Use the device needing attention:

1> Before power on the device, be sure to check the antenna interface whether is load, in order to avoid antenna interface short circuit or open circuit.

Note: Before powering on the device, should be first connect with antenna then connected to power supply, removal of device should be turn off the power at first. If you first connect the power or remove the device before powered up, it may cause the device damage.

2> Antenna selection, should be selected according to the use of the frequency band. If you required for long-distance transmission, had better to chose directional antenna improve the system gain.

Note:

- The system powered on must connected the antenna completely.
- The system must be powered off / disconnect the power before remove the antenna.

04- Configuration PTP et PMPT

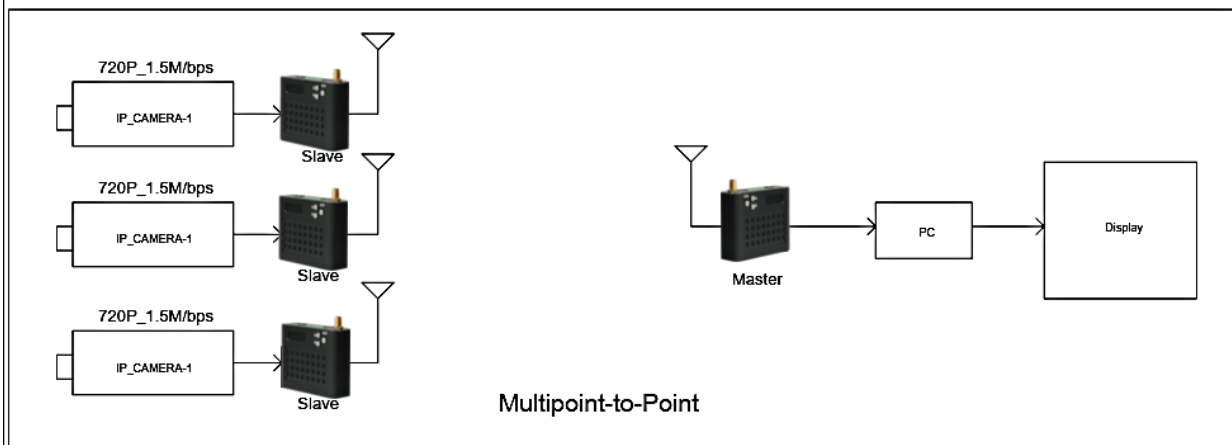
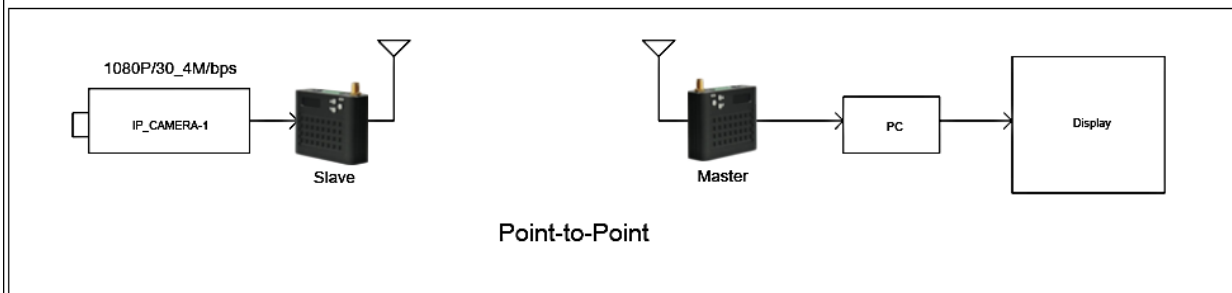

Model HYC-542

Power input DC 7~17V
 Ethernet 10/100 BaseT、Auto-MDI/X、IEEE 802.3
 TCP,UDP,TCP/IP,ARP,ICMP,DHCP,HTTP,SNMP,FTP,DNS
 Data input: RS-232&RS-485-H/RS-485-F, RJ45
 Output frequency 2402MHz-2482MHz,Step 1MHz adjustable
 Output power 30dBm/1W
 Bandwidth 2.0 MHz /4.0MHz/8.0MHz
 Encryption 128 bit AES (can customized 256 bit AES)
 Correction mechanism 32 bit of CRC,ARQ
 Modulation TDD-COFDM,Time division duplex mode
 RF Antenna interface MMCX
 Parameter control By adjusting the parameters of OLED control
 Dimensions 74 mm 52mm 20mm
 Weight 90g

04- Configuration PMPT with relay

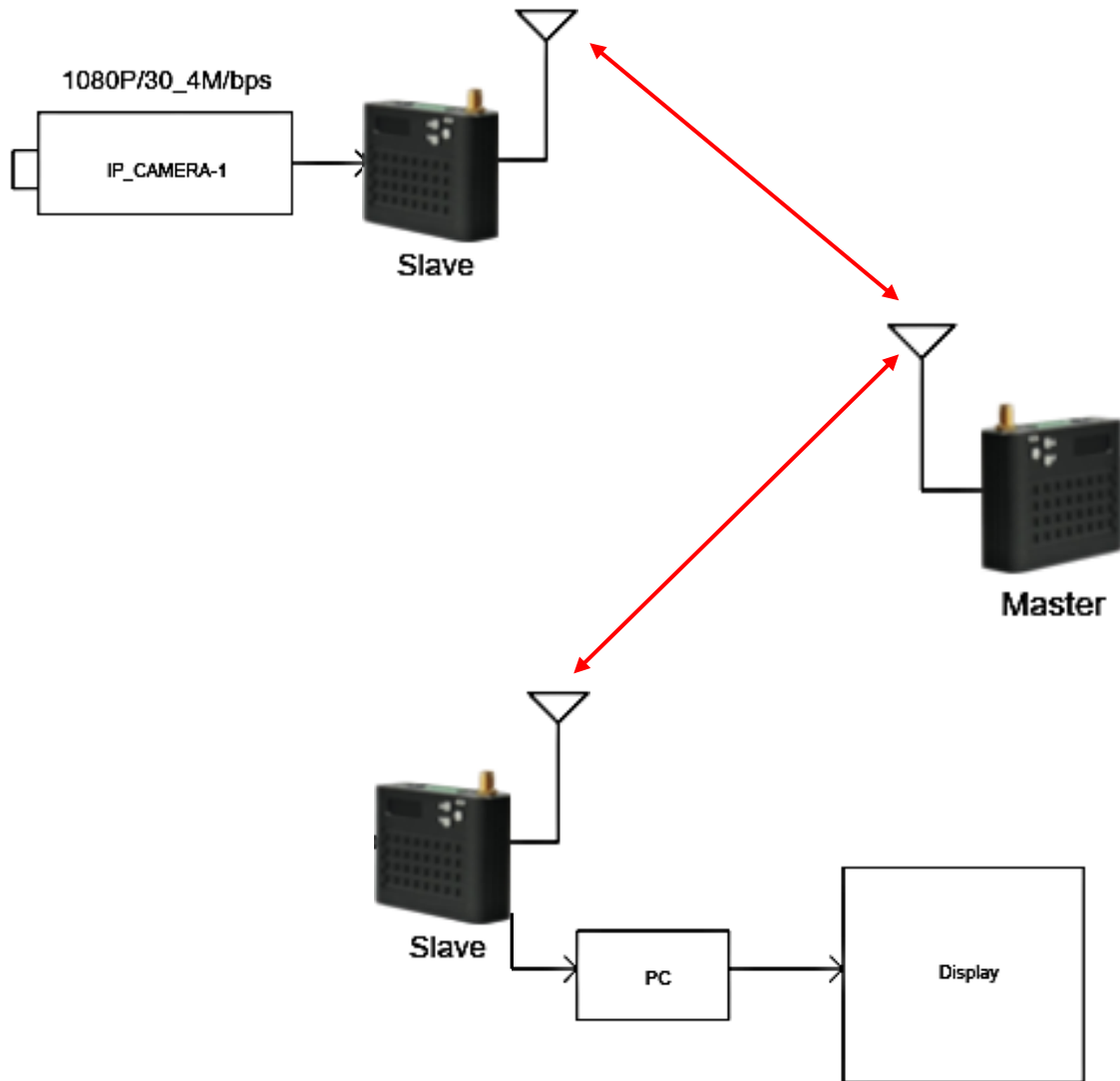

04- Images de la mise en service HYC540 (id HYC 542)



A la mise sous tension attendre 30 secondes la fin de l'initialisation



Choisir le N° du terminal de 1 à 256



Choisir la fonction Master ou Slave



Choisir le mode Slave



Choisir la Fréquence de trafic



Choisir le niveau de puissance à utiliser (27 dBm recommandé) et le débit Radio



Choisir la bande passante du canal

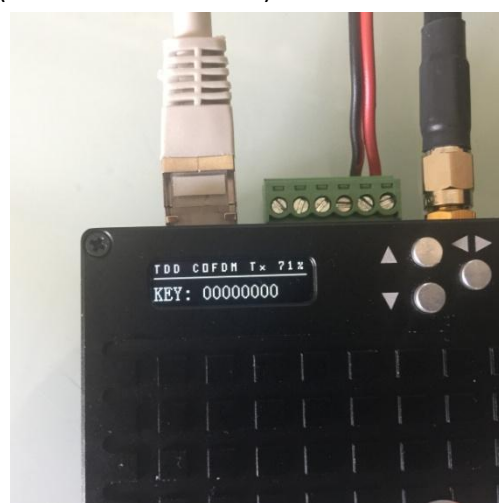

Choisir la clef de cryptage

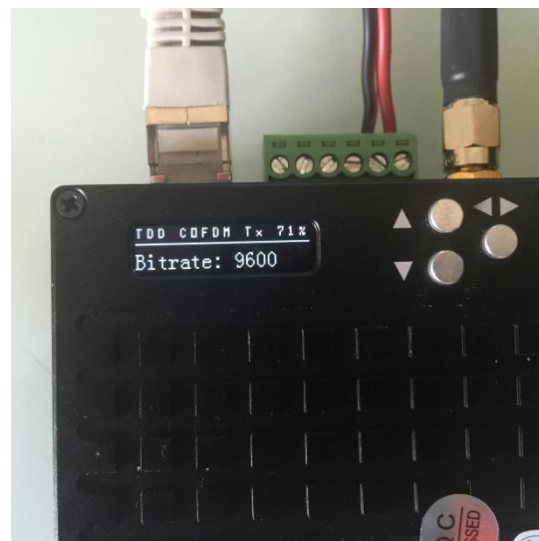

Choisir le type de Port Com RS 232 ou RS 485 et le débit souhaité



Choisir le format de parité du port de données RS232

Format des trames :

La transmission des données peut se faire suivant plusieurs formats (7 ou 8 bits) avec ou sans contrôle de parité (celle-ci) pouvant être gérée comme paire ou impaire); une trame commence par 1 bit de *start* ("0" logique) et se termine par 1 ou 2 bits de *stop* ("1" logique).

Les figures suivantes présentent l'allure de quelques formats :



RS232 **8N1** : 8 bits de données,
pas de parité, 1 bit de stop

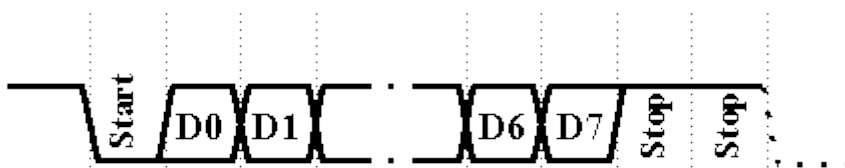

RS232 **8N2** : 8 bits de
données, pas de parité, 2 bits de stop

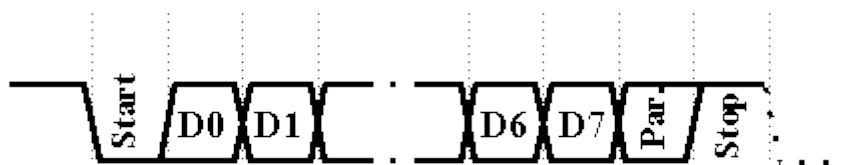

RS232 **8P1** : 8 bits de
données, avec parité, 1 bit de stop
(Parité paire : Par. = 1 si D(7:0) a un nombre pair de "1")
(Parité impaire : Par. = 1 si D(7:0) a un nombre impair de "1")

05- Mesures débit IP sur RJ45 HYC540

Pour 12 Mbps débit radio sur HYC540 Débit utile 8.4 Mbps

Pour 20 Mbps Débit radio sur HYC542 Débit utile 17 Mbps en canal 8 Mhz

HYC-540 Conducted test with -90 dB and -110 dB path budget losses

Cable Noise -120 dBm - RF Noise -105 dBm

Atténuation - 90 dB

TX power displayed dBm	Theoretical level dBm	Data stream IP Mbps	Performance%	SNR conducted Cable	SNR Spectrum
30	-60	8,73	37	60	45
27	-63	8,83	44	57	42
24	-66	8,40	40	54	39
20	-70	7,62	34	50	35

Atténuation - 110 dB

30	-80	3,19	10	40	25
27	-83	4,82	12	37	22
24	-86	4,19	7	34	19
21	-89	0,62	4	31	16
20	-90	0,56	3	28	15

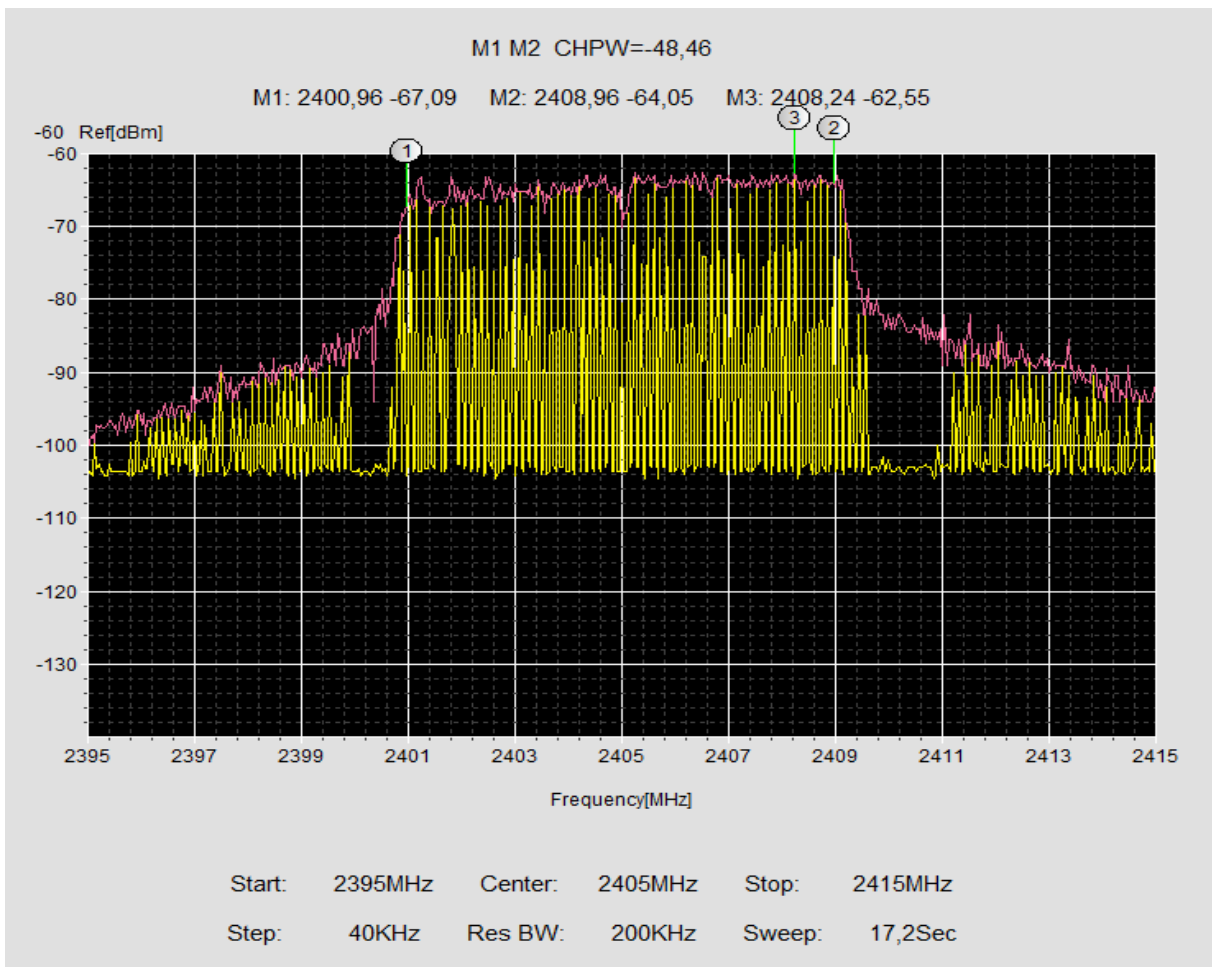

06 – HYC-540/542/550 EC Declaration of Conformity

Declaration of conformity

We **Hypercable s.a.r.l.**

Of **Innoveum - 74 Avenue Paul Sabatier
11.100 NARBONNE - FRANCE**

- N° SIRET : 384 007 894 00031 – Code TVA CEE: FR90384007894

Hereby declare that the following products:

Model Name **SkyMesh COFDM TDMA 2400 MHz radio PMPT**

Model Numbers **HYC-540/HYC-542/ HYC-550**

Conform to the essential requirements of the following EC Directives and FCC Regulations

ENC Directive 2004/108/EC

FCC CFR 47: Part 15.B:2012

This declaration is based on compliance of the product with the following standards:

EN61326.1:2006

EN55011:2009 + A1:2010

EN61000.3-2:2006 + A2:2009

EN61000.3-3:2008

EN61000.4-2:2009

EN61000.4-3:2006 + A1 :2008 + A2 :2010

EN61000.4-4 :2004 + A1 :2010

EN61000.4-5:2006

EN61000.4-6:2009

EN61000.4-11:2004

Signed by:

Name:  **Ducasse Jean-Claude**

Position: **CEO (Gérant)**

Date: **15th july 2017**

Hypercable
Telecommunications & Broadcast

INNOVEUM
Parc de la Coupe
74 Avenue Paul Sabatier
11100 NARBONNE
www.hypercable.fr

07- HYC-542-PRO 5/10 watts

HYC = 542PRO Radio PMPT TDMA COFDM SISO 5 watts RF
Ethernet vidéo audio data + RS232 & RS485



SMA jack female
output RF to
antenna

Keyboard for
configuration

Functions
Display



RJ45 IP
Ethernet I/O

Led status

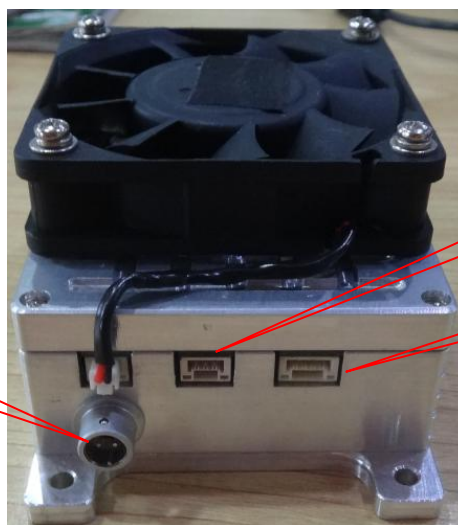

12 VDC Power input

RS432

RS 485

08- HYC-542-Functions reset

Step for the factory reset:

1. Power off the video transceiver HYC-542 first,
2. Then press "UP" and "Down" together,
3. Finally power on this radio once again.
4. When you press and hold down "UP" and "Down" together and restart the video transceivers, the screen will immediately be display "IP SCAN",
5. Once the screen display "IP SCAN", please **release the button quickly**.
6. " IP SCAN" will display all the time, do not turn off power while waiting for the system to complete initialization.
7. When the system recovery, the video transceiver will automatically login the system, the radio will works very well again.